

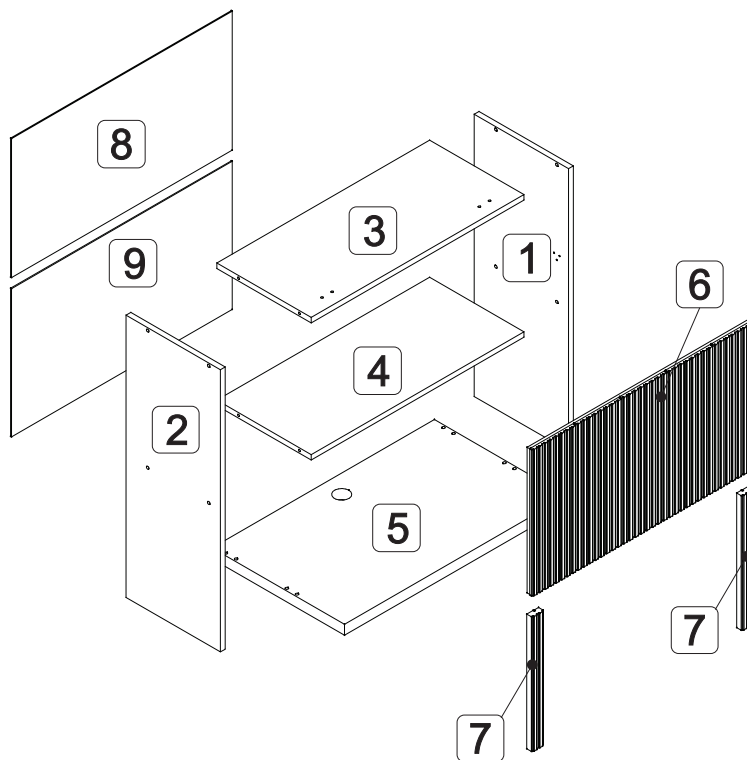

A marca da gestão florestal responsável
FSC® C168299

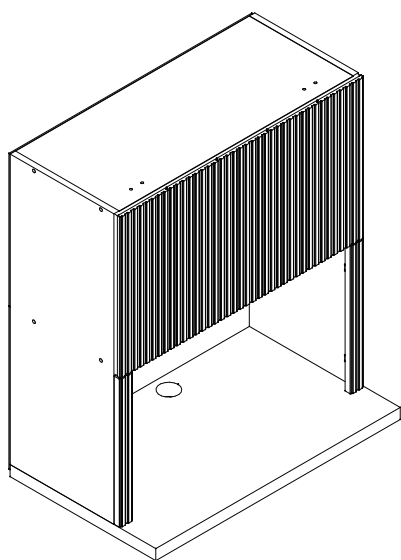





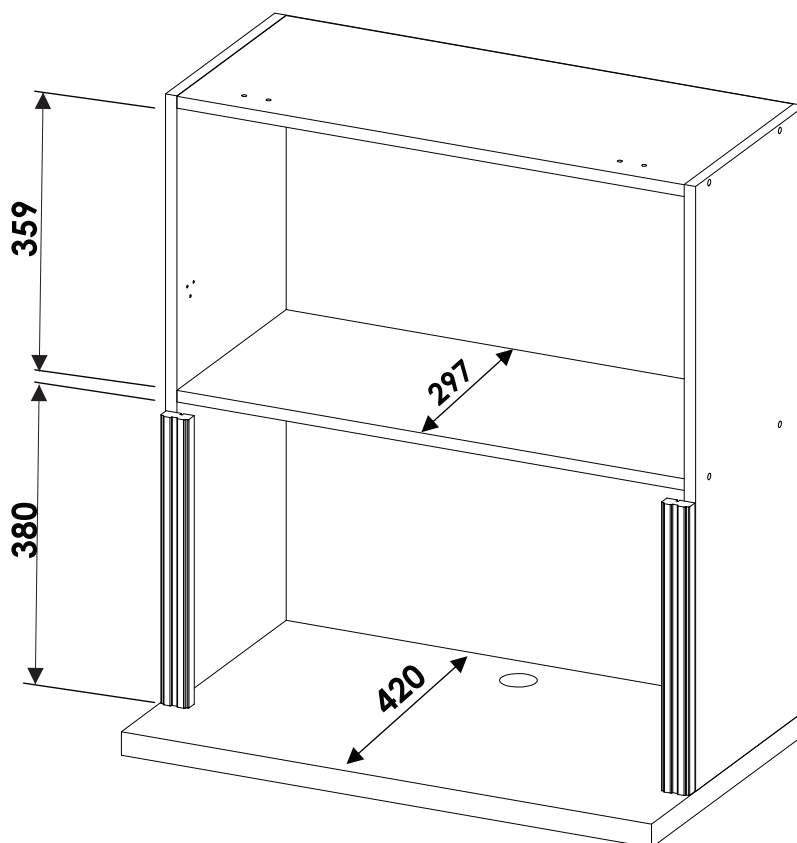
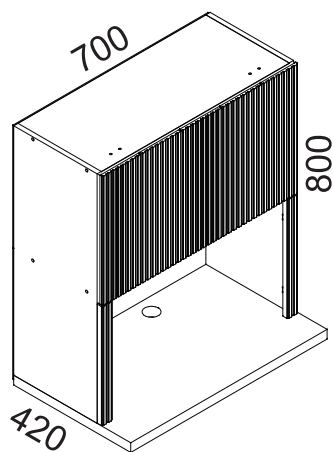

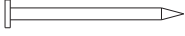
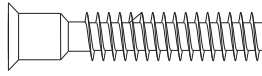
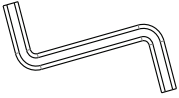
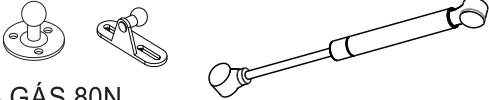
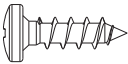

DIMENSÕES DOS ESPAÇOS INTERNOS (MEDIDAS EM MILÍMETROS)

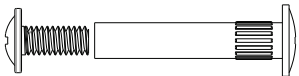
DIMENSÕES MÁXIMAS DO PRODUTO MONTADO

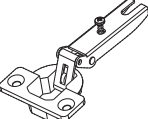

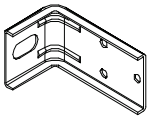
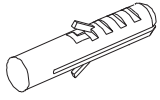
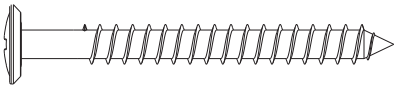
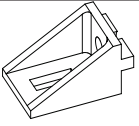
CÓDIGO	DESCRIÇÃO	QTDE	COMP	LARG	ESP
1	LATERAL DIREITA	1	770	297	15
2	LATERAL ESQUERDA	1	770	297	15
3	TAMPO	1	670	297	15
4	PRATELEIRA	1	670	297	15
5	BASE MICRO-ONDAS	1	700	417	30
6	PORTA MONTADA	1	698	399	18
7	MOLDURA LATERAL CANELADO	2	367	37	18
8	FUNDO TRASEIRO	1	695	379	2.5
9	FUNDO TRASEIRO	1	695	404	2.5

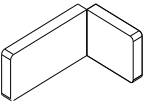
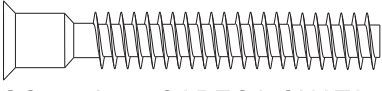
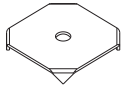
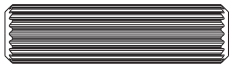
CÓDIGO/DESCRIÇÃO	QUANTIDADE	CÓDIGO/DESCRIÇÃO	QUANTIDADE
A  PREGO 10x10 COM CABEÇA	40	B  PARAFUSO 7x40mm CABEÇA CHATA	8
C  CHAVE ZETA	1	D  PISTÃO A GÁS 80N	1
E  PARAFUSO 4x14mm CABEÇA PANELA	24	F  PARAFUSO DE UNIÃO 17mm	5
G  PARAFUSO UNIÃO DE MÓDULOS 28MM	3	H  BATENTE DE SILICONE	2
I  DOBRADIÇA RETA CANECO 35mm	2	J  CALÇO DE DOBRADIÇA 05MM	2
K  CANTONEIRA METÁLICA PARA FIXAÇÃO NA PAREDE	4	L  BUCHA DE PAREDE DE 8MM	4
M  PARAFUSO 5x50mm CABEÇA FLANGEADA	4	N  SUPORTE ANGULAR	4
O  TAPA FURO ADESIVO 12mm	12	P  CAPA PLÁSTICA PARA CANTONEIRA	4
Q  PARAFUSO 7x70mm CABEÇA CHATA	4	R  FIXADOR FUNDO TRASEIRO METÁLICO	6
S  CAVILHA 8x30mm	4		

Ferramentas para montagem e instalação



PARAFUSADEIRA



FURADEIRA



NÍVEL



TRENA



MARTELO



CHAVE PHILIPS E FENDA

Montagem



Instalação

